

logitech®

# TAP ACCESSORIES



## Logitech Tap Accessories

With its 10.1" touch screen, Logitech Tap brings friendly touch controls to compatible video conferencing and collaboration applications. And thanks to a range of mounting and cabling options, you can integrate and secure Tap in almost any room, with the meeting room computer safely out of the way.

Designed for conference room tables with grommets, the Table Mount secures Tap in place while maintaining a low profile. For larger rooms,

choose the Riser Mount, which raises Tap from 14° to 30° for better visibility from across the room. Both mounts support through-grommet cabling for a clean appearance and swivel 180° for convenient operation from both sides of the table.

In hallways and smaller rooms, choose the Wall Mount for stand-up operation and to preserve table space. Tap is even designed with a 100mm VESA pattern for compatibility with thousands of third-party mounts and accessories.

Wherever you install Tap, the in-wall rated Logitech Strong USB cable offers convenient and robust cable routing. Available in 10 and 25 meter (32.8 and 82 ft) lengths, Logitech Strong USB offers up to 5x the length of ordinary USB cables so you can mount Tap and the meeting room computer almost anywhere. And because Logitech Strong USB is aramid-reinforced, plenum-rated, and Eca certified, you can hide cabling in walls, above ceilings, or within standard ¾" conduit.

## FEATURES & BENEFITS

### TABLE MOUNT

- 1 Low-Profile with Pivot:** Preserves Tap's sleek appearance and 14° screen angle while swiveling 180° for user convenience.
- 2 Fits Most Tables:** Adjusts to tables up to 50mm (2 in) in thickness, and through grommets from 51 - 89mm (2 - 3.5 in) in diameter.



- 3 Cable Management:** Supports down-routing of cables through the grommet for a clean appearance.



### RISER MOUNT

- 1 Raised Profile with Pivot:** Elevates Tap to a 30° screen angle for better visibility in larger rooms, while swiveling 180° for user convenience.
- 2 Fits Most Tables:** Adjusts to tables up to 50mm (2 in) in thickness, and through grommets from 51 - 89mm (2 - 3.5 in) in diameter.



- 3 Cable Management:** Supports down-routing of cables through the grommet for a clean appearance.

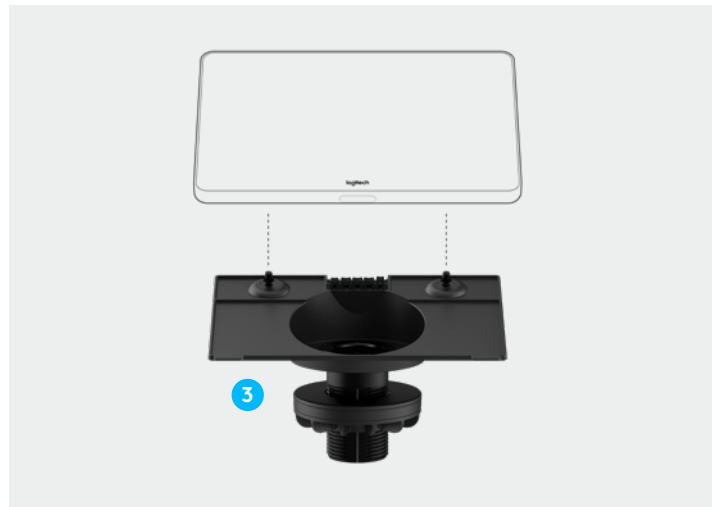

### WALL MOUNT

- 1 Flush Mounts to Any Wall:** The plate and cleat construction adds virtually no thickness for a sleek appearance.
- 2 HDMI Cable Cinch:** Hang an HDMI cable for easy access when deployed with applications that support wired content sharing.



- 3 In-Wall Cabling:** Supports Tap's rear and bottom cable exits so you can route cabling either within or down the wall.

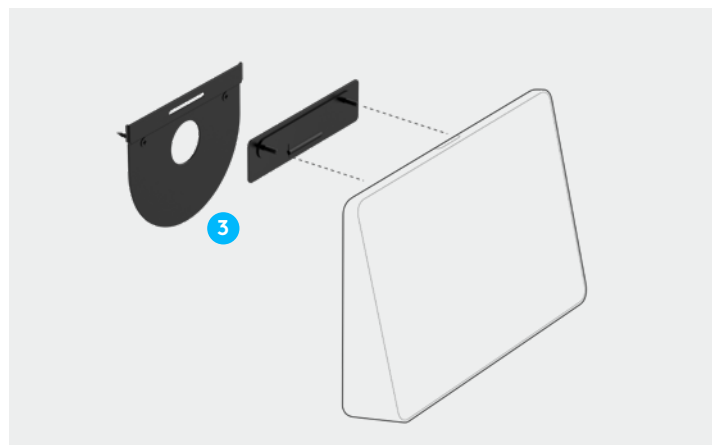

## PC MOUNT

- 1 Cable Retention:** Two-piece cable retention clamp relieves strain and keeps USB, HDMI, power, and network cables tight and secure.
- 2 Fits Most SFF PCs:** Robust steel mount fits small form factor (SFF) and Chromebox computers and mounting plates with a 75mm or 100mm VESA pattern.



- 3 Hideaway Design:** Includes hardware to mount a PC behind a display on the wall, or beneath a table.

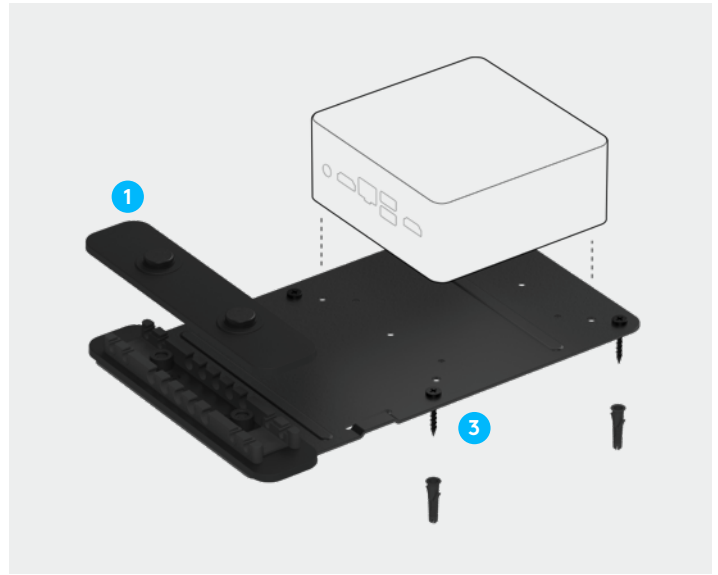

## LOGITECH STRONG USB CABLE



- 1 In-Wall Rated:** Aramid-reinforced, plenum-rated and Eca compliant for high pull-strength and durability in walls, above ceilings, or within standard 3/4" conduit.
- 2 Stays Connected:** Together with Tap's internal cable retention and strain relief systems, Logitech Strong USB stays securely connected, even when users move Tap around the room.
- 3 Compatible:** With support for USB 3.1, 3.0, and 2.0, the active optical cable is compatible with self-powered USB Type C devices like MeetUp and Rally Camera, or any USB Type C hub with its own power supply.
- 4 Hides the Computer:** Available in 10 and 25 meter (32.8 and 82 ft) lengths so you can move the meeting room computer — and its noise, heat, and cabling — away from participants and out of sight.

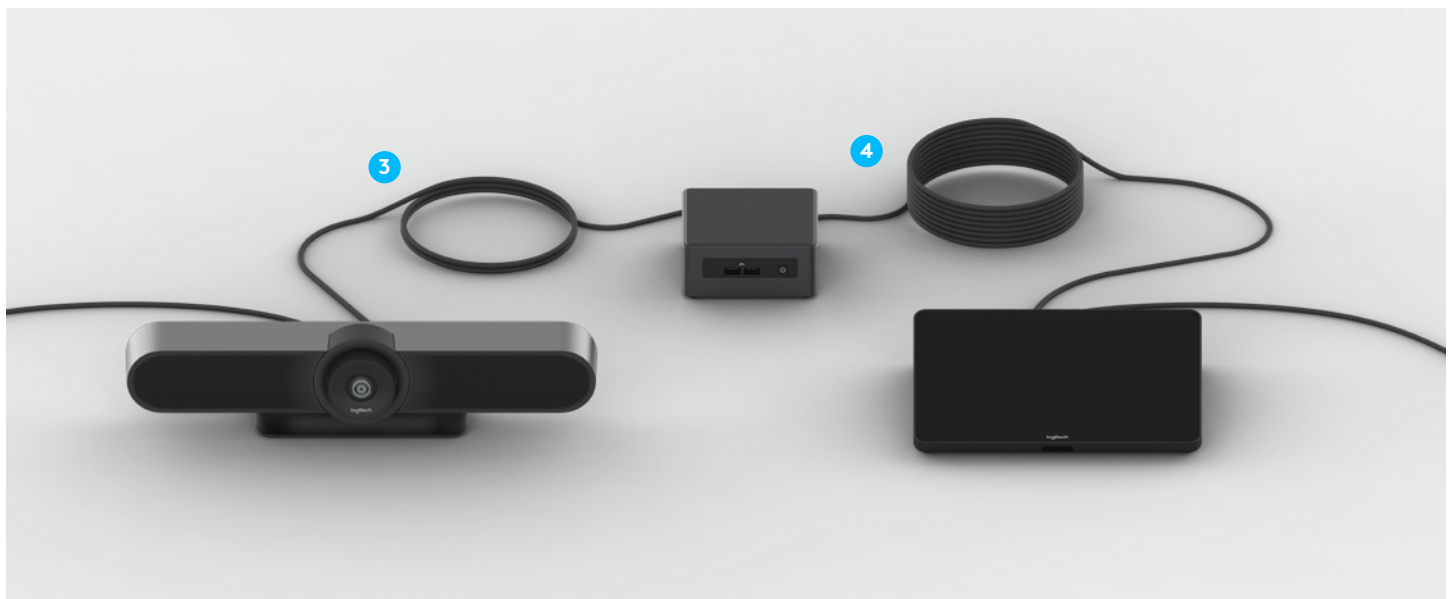

**TABLE MOUNT****Product Dimensions**

Tap with Table Mount  
2.4 x 9.6 x 7.0 in  
61 x 244 x 179 mm

**Compatibility**

Logitech Tap  
Table Thickness: 0.75 - 2.0 in (20 - 50 mm)  
Grommet Diameter: 2.0 - 3.5 in (51 - 89 mm)

**Inside the Box**

Table Mount Assembly  
Cable Cinch  
Documentation

**Warranty**

2-year limited hardware

**Part Numbers and UPC**

Part #: 939-001811  
UPC: 97855147325

**RISER MOUNT****Product Dimensions**

Tap with Riser Mount  
2.4 x 9.6 x 6.9 in  
102 x 244 x 174 mm

**Compatibility**

Logitech Tap  
Table Thickness: 0.75 - 2.0 in (20 - 50 mm)  
Grommet Diameter: 2.0 - 3.5 in (51 - 89 mm)

**Inside the Box**

Riser Mount Assembly  
Cable Cinch  
Documentation

**Warranty**

2-year limited hardware

**Part Numbers and UPC**

Part #: 939-001814  
UPC: 97855147332

**WALL MOUNT****Product Dimensions**

Tap with Wall Mount  
2.3 x 9.6 x 7.0 in  
58 x 244 x 179 mm

**Compatibility**

Logitech Tap

**Inside the Box**

Wall Mount Assembly (plate and cleat)  
HDMI Cable Clip  
Mounting Hardware  
Documentation

**Warranty**

2-year limited hardware

**Part Numbers and UPC**

Part #: 939-001817  
UPC: 97855147349

**PC MOUNT****Product Dimensions**

PC Mount with Cable Retention Clamp  
1.02 x 6.46 x 9.84 in  
26 x 164 x 250 mm

**Compatibility**

Small form factor (SFF) computer with  
75 x 75 mm or 100 x 100 mm VESA pattern

**Inside the Box**

PC mount  
VESA Mounting Plate  
Cable Retention Clamp  
Mounting Hardware  
Documentation

**Warranty**

2-year limited hardware

**Part Numbers and UPC**

Part #: 939-001825  
UPC: 97855148100

**LOGITECH STRONG USB CABLE****Product Specifications**

USB Type A (male) to USB Type C (male)  
active optical cable  
Aramid-reinforced sheath  
3/4" conduit friendly

**Product Dimensions**

Available Lengths:  
10m (32.8 ft)  
25m (82 ft)

**Compatibility**

USB 2.0/3.0/3.1  
Logitech Tap  
Logitech MeetUp  
Logitech Rally Camera  
Self-powered USB 2.0/3.0/3.1 hubs and devices  
with external power supplies  
*Not compatible with Logitech BRIO and other  
USB bus-powered devices*

**Certifications**

Plenum Rated  
Eca/IEC 60332-1-2 Compliant

**Inside the Box**

Logitech Strong USB-A to USB-C Cable: 10 or  
25 meters (32.8 or 82 ft)  
USB-C extension cable for tight spaces:  
152 mm (6 in)  
Documentation

**Warranty**

2-year limited hardware

**Part Numbers and UPC**

10 Meter  
Part #: 939-001799  
UPC: 97855147097

25 Meter

Part #: 939-001802  
UPC: 97855147103

